



Controls and accessories

for Fun Coil Units

Built-in electronic controls

for Fan Coils with Asynchronous Motor

for **Carisma CRC** versions with casing



CB



CB-T



CB-C



CB-AUT



CB-IAQ



CB-R-IAQ



CB-AUT-IAQ

Functions	Identification						
	CB	CB-T	CB-C	CB-AUT	CB-IAQ	CB-R-IAQ	CB-AUT-IAQ
ON-OFF switch	✓	✓	✓	✓	✓	✓	✓
ON-OFF switch for Crystall electrostatic filter or electric heater					✓	✓	✓
Manual 3 speed switch	✓	✓	✓	✓	✓	✓	✓
Manual/Automatic 3 speed selection				✓			✓
Summer/Winter switch		✓		✓		✓	✓
Remote centralized Summer/Winter switch or by an automatic change-over fitted on the water pipe			✓	✓		✓	✓
Automatic Summer/Winter switch with neutral zone for 4 pipe installation with 2 valves				✓			✓
Room thermostat for fan control (ON-OFF)		✓	✓	✓		✓	✓
Room thermostat for 1 valve control (2 pipe installation)		✓	✓	✓		✓	✓
Room thermostat for 2 valve control (4 pipe installation)		✓	✓	✓		✓	✓
Simultaneous thermostatic control of the valves and fan				✓			✓
Room thermostat for chilled water valve (SUMMER) and electric heater (WINTER) control (in winter only the electric heater is working)		✓	✓	✓		✓	✓
Room thermostat for fan and electric heater control (not for Crystall)				✓		✓	✓
Installation of electronic low temperature cut-out thermostat (TME)			✓			✓	
Installation of bimetallic low temperature cut-out thermostat (TMM)		✓					
Installation of electronic low temperature cut-out thermostat (NTC)				✓			✓

Wall electronic controls

for Fan Coils with Asynchronous Motor

for all Carisma - SkyStar - Maestro Range



WM-AU



WM-T



WM-TQR



T-MB2



WM-503-AC-EC

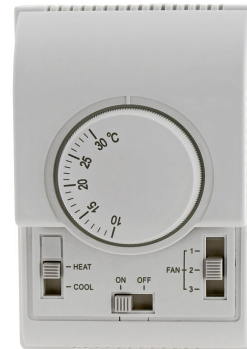

TS2



WM-3V

Functions	Identification						
	WM-3V	WM-T	WM-TQR	WM-AU	WM-503-AC-EC	T-MB2	TS2
ON-OFF switch	✓	✓	✓	✓	✓	✓	✓
ON-OFF switch for Crystall electrostatic filter or electric heater			✓	✓		✓	
Manual 3 speed switch	✓	✓	✓	✓	✓	✓	✓
Manual/Automatic 3 speed selection				✓	✓	✓	
Summer/Winter switch		✓	✓	✓	✓	✓	✓
Remote centralized Summer/Winter switch or by an automatic change-over fitted on the water pipe ^(*)			✓	✓		✓	
Automatic Summer/Winter switch with neutral zone for 4 pipe installation with 2 valves ^(*)				✓	✓	✓	
Room thermostat for fan control (ON-OFF)		✓	✓	✓	✓	✓	✓
Room thermostat for 1 valve control (2 pipe installation)		✓	✓	✓	✓	✓	✓
Room thermostat for 2 valve control (4 pipe installation)		✓	✓	✓	✓	✓	
Simultaneous thermostatic control of the valves and fan		✓	✓	✓	✓	✓	✓
Room thermostat for chilled water valve (SUMMER) and electric heater (WINTER) control (in winter only the electric heater is working)		✓	✓	✓	✓	✓	
Room thermostat for fan and electric heater control (not for Crystall)			✓	✓		✓	
Installation of bimetallic low temperature cut-out thermostat (TMM)		✓					
Installation of electronic low temperature cut-out thermostat (NTC) ^(*)			✓	✓	✓	✓	

NOTE: the WM-AU, T-MB2 and WM-503-AC-EC controls can be used only with dedicated power unit (see technical manuals and/or price list)

^(*)for the controls that use the power unit, check on the technical manual if the feature is available.

Remote control RT03 and T-MB2 wall control

for all the Carisma and SkyStar Range with Asynchronous Motor and with EC Brushless Electronic Motor and Inverter Board

All Carisma and SkyStar units can be supplied with a microprocessor management and control system with **infra-red remote control** and liquid crystal display or with the **T-MB2 wall control** to be used with **MB board**.

RT03 remote control



T-MB2 wall control with LCD color display and WiFi



PSM-DI

multifunction control panel

for all the Carisma and SkyStar Range with Asynchronous Motor and with EC Brushless Electronic Motor and Inverter Board

Another option available for the serial communication between the units is the possibility to connect up to 60 Carisma and SkyStar units in series (the maximum length of the connection cable must not exceed 800 m) and manage them with just one **wall mounted intelligent PSM-DI controller**.

The wall mounted controller can be used to set the operating mode for each individual unit connected, display the operating conditions of each individual unit, and set the ON/OFF time sets for each day of the week.

If **more than 60 units need to be connected, two or more** wall mounted intelligent controllers must be used. Each wall control will manage only the connected units. Each unit must have a **MB board**.

PSM-DI control panel



T-DI

Touch screen multifunction control panel

Carisma and SkyStar Cassette fan coil ranges with AC asynchronous motor and with EC electronic motor and inverter board

The T-DI multifunction control panel lets supervise and control more units with MB or SIOS boards; the panel is equipped with a 7 inches touch screen display and a serie of graphical pages that allows an easy reading of the data sent by the fan coils and the management of up to 60 units (max. 60 units: SIOS + MB).

With the multifunction control panel T-DI it is also possible to control the units remotely with the specific **Sabiana Cloud App for Android and iOS**.

The Sabiana Cloud APP is simple to use and lets have complete control of all the connected units.

T-DI Touch screen multifunction control panel



SabWeb

Web gateway for Sabiana Cloud

Carisma and SkyStar Cassette fan coil ranges with AC asynchronous motor and with EC electronic motor and inverter board

With the Web gateway for “Sabiana Cloud” it is possible to control remotely up to 60 units, equipped with MB or SIOS boards (max. 60 units: SIOS + MB), with the specific APP for Android and iOS.

The “Sabiana Cloud” APP is simple to use and lets have complete control of all the connected units.

Web gateway for Sabiana Cloud



Sabianet

management system for a network of fan coils

for all the Carisma and SkyStar Range

Sabianet is a centralised control system for networks of MB fan coils, based on software that runs **on Linux operating system** (the program is provided pre-installed on a PC). The Sabianet software **offers a practical and economical solution** for managing the fan coils, with the simple click of the mouse.

The main characteristics include simplicity of use, an extremely complete and functional weekly program, and the possibility to access the historical operating data for each individual unit connected.

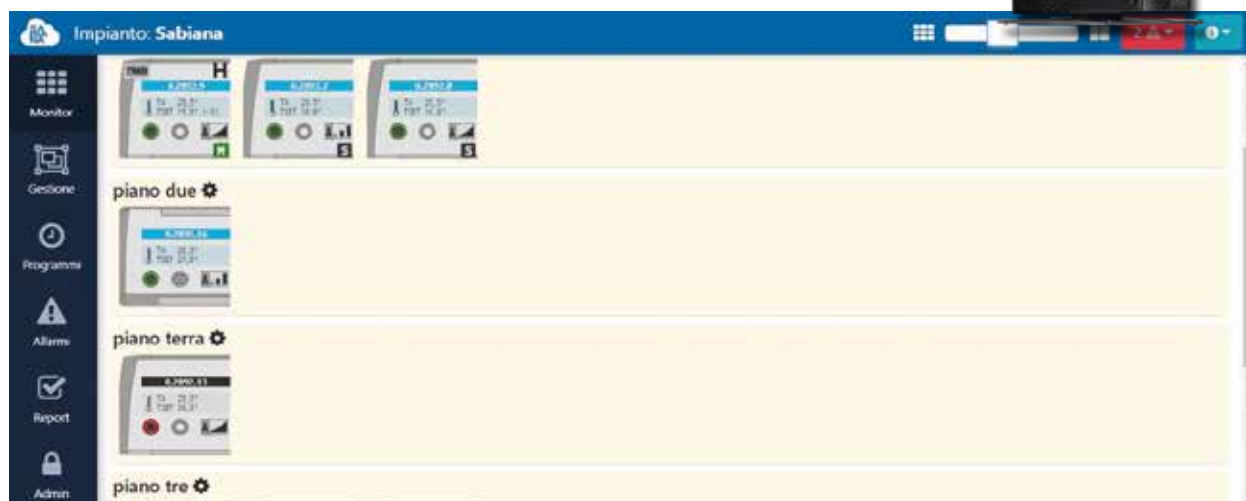

Sabianet screenshot

MB board for all the Carisma and SkyStar Range

The MB boards, besides being used with **T-MB2** controls, with infra-red remote control units, with **PSM-DI** and with the units managed with **Sabianet** software, can also be interfaced with BSM supervisory systems that use **Modbus** communication protocol.

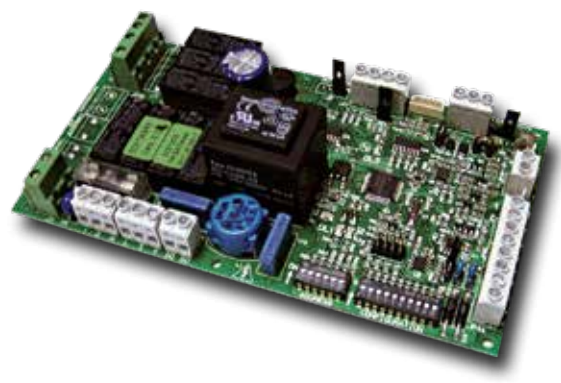

KNX bus system

The KNX bus system is a building automation standard for controlling, managing and monitoring a wide range of products for:

- heating, cooling, ventilation
- lighting
- alarm systems
- audio and video systems
- electricity and gas



Since 2016, Sabiana is a certified member of the KNX association and the certified products can be added to this system in compliance with the tests carried out at KNX laboratories.

KNX devices

The Sabiana WM-KNX room thermostat controls and adjusts the temperature of a room or area in a building. In combination with one or several UP-KNX power units, the thermostat is able to control the operation of terminal units such as fan coils. The appliance consists of an LCD display with adjustable backlight and a sensor for measuring the room temperature.

WM-KNX is suitable for installation in a recessed wall box.

Recessed thermostat

WM-KNX
Code 9066679



with rectangular plate



With square plate

Power unit

UP-KNX
Code 9066680



Electronic controls

for Fan Coil Units with EC Brushless Electronic Motor and Inverter Board



CB-T-ECM

for CRC-ECM, CRT-ECM and CRR-ECM versions



CB-T-ECM-IAQ

for CRC-ECM and CRR-ECM version



WM-AU



T-MB2



WM-503-AC-EC



WM-S-ECM

for all the Carisma ECM and SkyStar ECM Range

RT03 infra-red remote control

T-MB2 wall control with LCD color display and WiFi

PSM-DI multifunction control

Sabianet management system for a network of fan coils

Controls for KNX systems

for the characteristics, see previous pages

Functions	Identification					
	built-in		wall			
	CB-T-ECM	CB-T-ECM-IAQ	WM-AU	T-MB2	WM-503-AC-EC	WM-S-ECM
ON-OFF switch	✓	✓	✓	✓	✓	✓
Room thermostat for chilled water valve (SUMMER) and electric heater (WINTER) control (in winter only the electric heater is working)		✓	✓	✓		
Manual 3 speed switch or automatic continuous speed control	✓	✓	✓	✓	✓	✓
Summer/Winter switch	✓	✓	✓	✓	✓	✓
Continuous speed control based on the difference between ambient temperature and Set temperature (speed switch in Auto position)	✓	✓	✓	✓	✓	✓
Remote centralized Summer/Winter switch or by an automatic change-over fitted on the water pipe ^(*)			✓	✓		
Room thermostat for fan control (ON-OFF)	✓	✓	✓	✓	✓	✓
Room thermostat for 1 valve control (2 pipe installation)	✓	✓	✓	✓	✓	✓
Room thermostat for 2 valve control (4 pipe installation)	✓	✓	✓	✓	✓	✓
Simultaneous thermostatic control of the valves and fan	✓	✓	✓	✓	✓	✓
Room thermostat for fan and electric heater control (not for Crystall)		✓	✓	✓		
Installation of electronic low temperature cut-out thermostat (NTC) ^(*)	✓	✓	✓	✓	✓	✓

NOTE: the WM-AU, T-MB2 and WM-503-AC-EC controls can be used only with dedicated power unit (see technical manuals and/or price list)

^(*)for the controls that use the power unit, check on the technical manual if the feature is available.

Accessories

for Carisma range

CRC/CRC-ECM - CRT-ECM - CRR-ECM - CRSL/CRSL-ECM - CFF/CFF-ECM - CCN/CCN-ECM

All Sabiana Carisma fan coils, whether with **Asynchronous Motor** or with **Electronic Motor and Inverter**, can be equipped with a **very large series of Accessories**, such as, to name only the most common, numerous types of regulating valves, sturdy support feet, rear cover panel for installing against glass, additional electrical resistances, auxiliary condensation drain pump, outdoor air intake louvre, inlet and outlet ducts and grills for ducted installations.



Accessories		Identification					
		CRC CRC-ECM	CRT-ECM	CRR-ECM	CFF CFF-ECM	CRSL CRSL-ECM	CCN CCN-ECM
Main coil 3 way valve	VBP	✓	✓	✓		✓	✓
Additional coil 3 way valve	VBA	✓	✓			✓	✓
Simplified kit for 3 way valve for main and additional coil (concealed model only)	VS	✓	✓			✓	✓
3 way double valve kit for 4 tube installation and single coil	V3M4X2 V3S4X2	✓	✓			✓	✓
2 way valve for main and additional coil	V2	✓	✓	✓	✓	✓	✓
3 way valve for main and additional coil	V3	✓	✓		✓	✓	✓
Balancing valves independent from the system pressure for main and additional coil	V20 VBP V20 VBA	✓	✓			✓	✓
Electric heater (not available with Crystall filter)	BEL	✓	✓			✓	✓
Extension condensate collection tray to cover valve assembly (for vertical units)	BSV	(MV-MVB-IV)	(MV-MVB-IV)	✓		✓	
Extension condensate collection tray to cover valve assembly (for MO horizontal units)	BSO	(MO)	(MO)				✓
Extension condensate collection tray to cover valve assembly (for IO horizontal units)	BSI-C	(IO)	(IO)			✓	
Horizontal condensate collection tray kit (for IV concealed version)	BSI-W				(CFF-IV)		
Condensate pump (for vertical units)	DRPV-C	(MV-MVB-IV)	(MV-MVB-IV)			✓	
Condensate pump (for horizontal units)	DRPO-C	(MO)	(MO)				
Condensate pump (for horizontal units)	DRPI-C	(IO)	(IO)			✓	
Plastic condensate drain pipe with fast connection	SCR	✓	✓			✓	✓
Feet	PAP	✓	✓	✓	✓		
Aluminium low intake grid	GAP	✓	✓				
Frontal intake kit	KAF	(IV-IO)	(IV-IO)			✓	
Rear closing panel (for vertical units)	PCV	(MV-MVB)	(MV-MVB)				
Bottom closing panel (for horizontal units)	PCO	(MO)	(MO)				
Fresh air mixing damper (mounted on the unit)	SAEM	(MV)	(MV)				
Fresh air mixing damper (not mounted)	SAE	(IV-IO)	(IV-IO)				
Belimo motor (not available with ECM range)	BESAE	(MV-IV-IO)					
Straight inlet flange	FRD	✓	✓			✓	
90° inlet flange	FR 90	✓				✓	
Air inlet grid (to be used with FR 90 90° inlet flange)	GRAP	✓				✓	
Air inlet grid (to be used with FRD straight inlet flange)	GRAG	✓	✓			✓	
Straight outlet flange	FMD	✓	✓			✓	
90° outlet flange	FM 90	✓				✓	
Air outlet grid	BMA	✓	✓			✓	
Air inlet spigot plenum	PRC	✓				✓	
Spigot diffuser	PMC	✓				✓	
Air inlet grid with filter (to be fitted to the FR 90 90° inlet flange)	GRAFP	✓					
Air inlet grid with filter (to be fitted to the FRD straight inlet flange)	GRAFG	✓					
Condensate drain pump	PCC						✓
Fresh air connection	FRC	✓					✓
Hotel fan kit (frontal return and supply)	CHK	(IO)					
Silencer plenum	BXS	IV-IO				✓	

VBP Main coil 3 way valve

Control valve kit:
3 way valve, ON-OFF,
with electric motor and mounting kit
with micrometric lockshield valve.

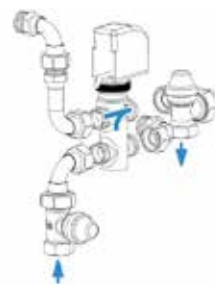

VBA Additional coil 3 way valve

Control valve kit:
3 way valve, ON-OFF,
with electric motor and mounting kit
with micrometric lockshield valve



VS Simplified kit for 3 way valve for main and additional coil (concealed model only)

3 way valve, (ON-OFF)
with electric motor and mounting kit.
Valve with flat connection without micrometric lockshield valve..

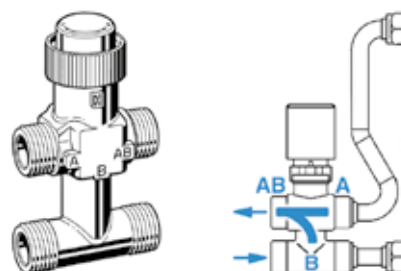

V20VBP Valve kit with pressure independent control valves for main and additional coil

(not mounted)

Kits are available with flow ranges:

- 30 - 200 l/h
- 100 - 575 l/h
- 220 - 1330 l/h

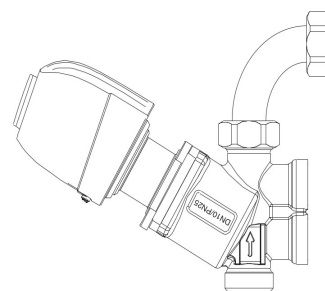

V2 2 way valve for main and additional coil

Control valve kit:
2 way valve, ON-OFF,
with electric motor and mounting kit

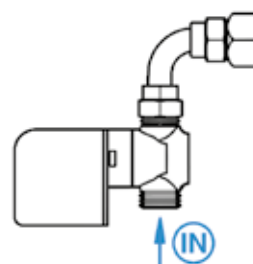

V20VBP Balancing valves independent from the system pressure for main coil (Oventrop)

V20VBA Balancing valves independent from the system pressure for additional coil (Oventrop)

V2DFBP Balancing valves independent from the system pressure for main coil (Danfoss)

V2DFBA Balancing valves independent from the system pressure for additional coil (Danfoss)

BEL **Electric heater**
(not available with Crystall filter)

1 PHASE 230V
Electric heater with integral: safety thermostat and relay control..

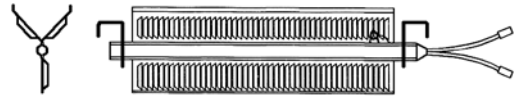

BSV **Extension condensate collection tray to cover valve assembly**
(for vertical units)

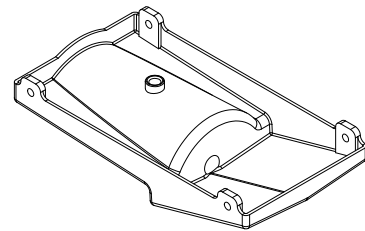

BSO **Extension condensate collection tray to cover valve assembly**
(for MO horizontal units)

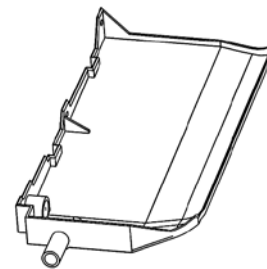

BSI-C **Extension condensate collection tray to cover valve assembly**
(for IO horizontal units)

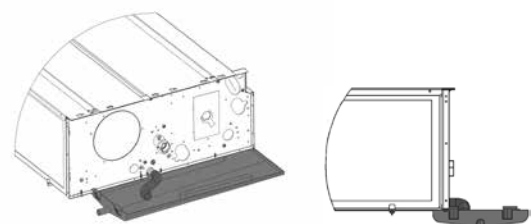

DRPV-C **Condensate pump**
(for vertical units)



DRPO-C **Condensate pump**
DRPI-C (for horizontal units)



DRPO-C



DRPI-C

SCR **Plastic condensate drain pipe with fast connection**
Allows correct condensate drain.

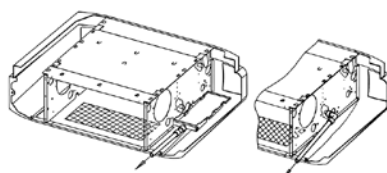

CRC / CRC- ECM
CRT-ECM

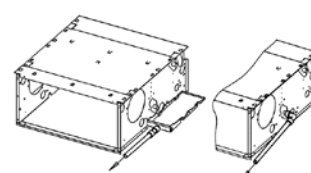

CRSL / CRSL- ECM
CCN / CCN-ECM

PAP **Feet**

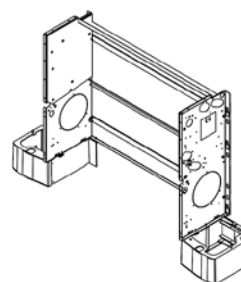

GAP **Aluminium low intake grid**

To be installed with PAP feet.

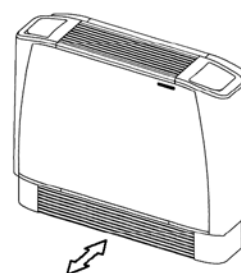

KAF Frontal intake kit

Bottom closing panel and filter sliding guide.

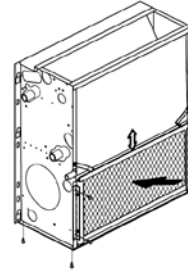

PCV Rear closing panel
(for vertical units)

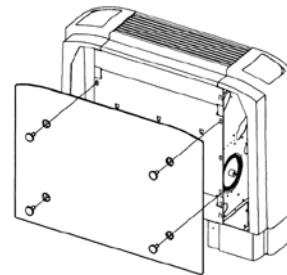

PCO Bottom closing panel
(for horizontal units)

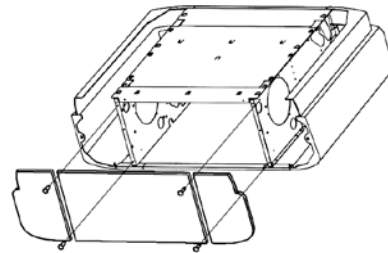

SAEM Fresh air mixing damper

Mounted on the unit with feet and intake grid included.
Can be motorized on request.

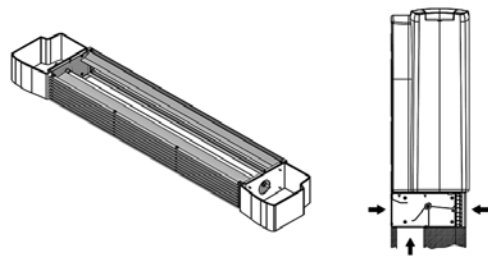

SAE Fresh air mixing damper

Not mounted.
Can be motorized on request.

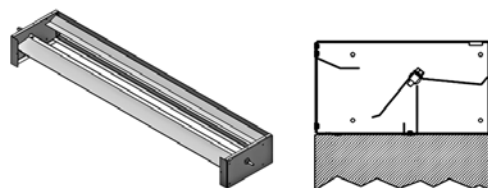

BESAE

Belimo motor

(not available with ECM range)

Fitted on the unit for motorized working of the damper.

(available with "IAQ" control only)

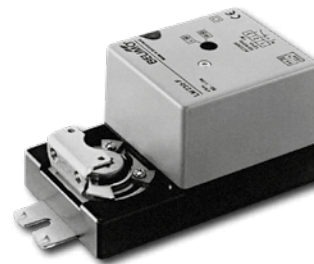

FRD

Straight inlet flange

Can be used together with GRAG air inlet grid.

Made of galvanized steel.



FR 90

90° inlet flange

Can be used together with GRAP air inlet grid.

Made of galvanized steel.



GRAP

Air inlet grid

To be used with FR 90 90° inlet flange.

Made of anodized aluminium.

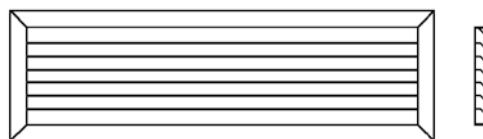

GRAG

Air inlet grid

To be used with FRD straight inlet flange.

Made of anodized aluminium..

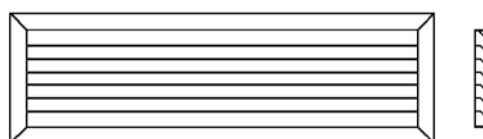

FMD Straight outlet flange

Made of galvanized steel.



FM 90 90° outlet flange

Made of galvanized steel insulated with polyethylene lining..



BMA Air outlet grid

Double louvre grid to be fitted to the duct, to the FMD straight outlet flange or to the FM 90 90° outlet flange.
Made of anodized aluminium.

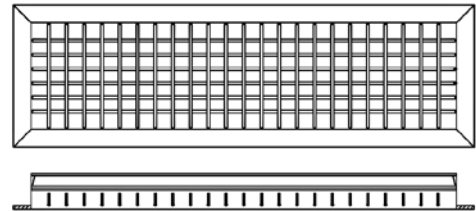

PRC Air inlet spigot plenum

Made of galvanized steel insulated with polyethylene lining.



All the plenums are supplied with spigots for the connection of flexible ducts..

PMC Spigot diffuser

Made of galvanized steel insulated with polyethylene lininge.



All the plenums are supplied with spigots for the connection of flexible ducts.

GRAFP **Air inlet grid with filter**

To be fitted to the FR 90 90° inlet flange.
Made of anodized aluminium.

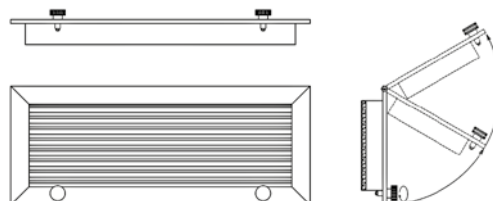

GRAFG **Air inlet grid with filter**

To be fitted to the FRD straight inlet flange.
Made of anodized aluminium.

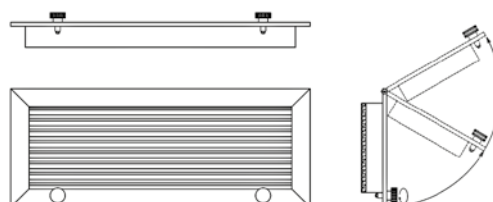

PCC **Condensate drain pump**

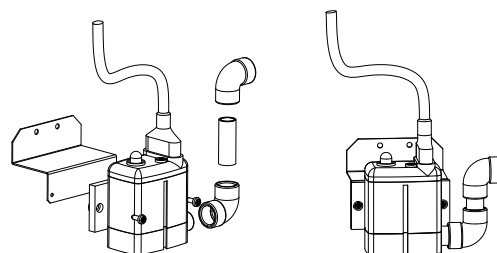

FRC **Fresh air connection**

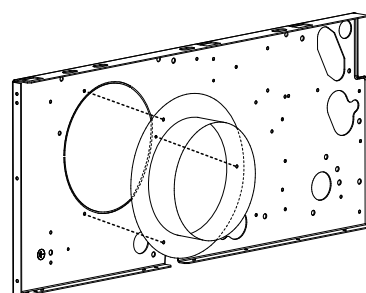

CHK **Hotel fan kit
(frontal return and supply)**

For concealed installation.

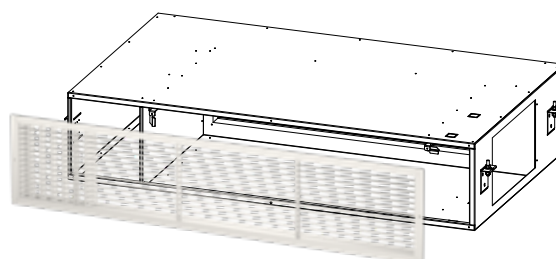

BXS

Silencer plenum

(for Carisma CRSL / CRSL-ECM and
CRC / CRC-ECM, IV-IO models only)

Made of galvanised steel metal sheet, lined
internally with a reinforced glass wool mat on
both sides with a black glass coating.

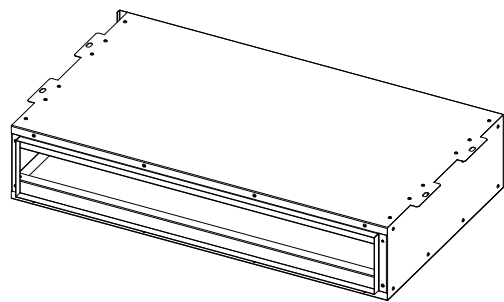



Follow us



Sabiana app



Výrobce si vyhrazuje právo měnit parametry svých výrobků bez předchozího upozornění.
Aktualizované vydání naleznete na internetové adrese www.hydronix.cz



Praha
Jesenická 513
252 44 Psáry, Dolní Jirčany
☎ +420 244 466 792-3
✉ praha@hydronix.cz

Brno
Šámalova 78
615 00 Brno
☎ +420 545 247 246
✉ brno@hydronix.cz

Bratislava
Hattalova 12/C
831 03 Bratislava
☎ +421 650 822 284
✉ bratislava@hydronix.sk